

For additional information please visit [inhausurfaces.com](http://inhausurfaces.com) or call 1.888.255.3412.



## CAUTION:

- Use a dust mask, safety glasses and gloves when cutting SONO Eclipse flooring.
- If using power tools to cut planks, always cut in a well-ventilated area.
- Never use tools designed for other flooring installation systems (eg. seam rollers, tap blocks, etc.).
- Do not directly hit or press SONO Eclipse with any installation tools such as tap blocks, hammers, mallets or seam rollers as this can cause damage to the product's locking system.
- Never wax, polish or use abrasive cleaners on SONO Eclipse floors as they may damage the floor's finish beyond repair.
- SONO Eclipse is not recommended in areas where the floor might experience temperature extremes beyond -40°F (-40°C) or greater than 150°F (65°C).

## INTENDED USE

SONO Eclipse floors are intended for indoor use only and can be installed in any room as long as it does not have in-floor drainage. All SONO Eclipse floors have been designed to withstand the requirements of the busiest households as well as light commercial applications. The occupied use temperature range is assumed to be between 50°F (10°C) and 100°F (38°C). If you are installing SONO Eclipse floors in a light commercial environment, please refer to the SONO Eclipse Approved Placement document and read the warranty documentation specific to your application to determine its suitability.

## HANDLING

- Handle SONO Eclipse with care prior to installation; do not drop cartons, protect edges, etc.
- Always store SONO Eclipse cartons flat and properly supported on a level surface.
- Never lean cartons against walls and do not store them on saw-horses or similar equipment that does not fully support the full length of the cartons.

## PRE-INSTALLATION

Prior to installing, check all planks for color against samples used in selection to ensure correct product. Further, inspect for defects and transportation damage. Any planks that show damage or defects should not be used.

### ACCLIMATION

Best practices require up to 24-48 hours to acclimate SONO Eclipse to the conditions of the installation area. To acclimate: cross-stack unopened cartons in the installation area and at room temperature approx. 18°C-20°C (65°F-68°F). Do not install cold or frozen planks.

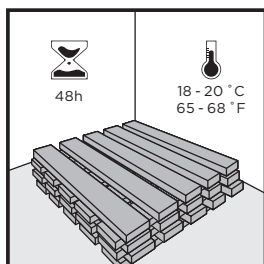

### EXPANSION SPACE

It is necessary to leave a 3/8" (10mm) expansion space around the perimeter of the room and all other objects (e.g. toe kicks, plumbing, etc.). The expansion space will be covered by the wall base or quarter round once the floor is installed. If installing in moisture prone areas, please refer to the Recommendations for Wet Area Installation section of this guide.

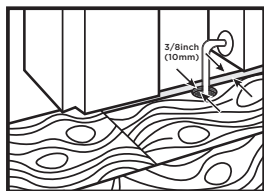
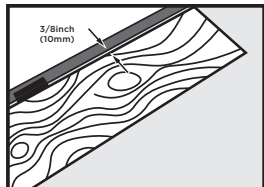

### TRANSITIONS

It is highly recommended that transitions (T-Moldings) be used to separate rooms. If using transitions, ensure the required 3/8" (10mm) expansion space is left between SONO Eclipse planks and the vertical section of the T-Molding. Transitions must be used if changing direction (orientation) of the planks between rooms.

### MAXIMUM ROOM SIZE

SONO Eclipse floors can be installed in a single room up to 100 linear feet (30m) in length and/or 100 linear feet (30m) in width. Installations in rooms that are over 100 linear feet (30m) in length or width must use transitions.

### INSTALLATION LAYOUT

There are no rules when it comes to the direction you choose to lay planks in your installation. Typically, SONO Eclipse flooring installations are oriented in the following manner: Parallel to the longest wall in the room, or perpendicular to the main window in the room.

### CUTTING PLANKS

SONO Eclipse flooring planks are designed to be cut using a score and snap method using a standard utility knife. Simply score planks and bend to snap or cut. Always use a straight edge and appropriate safety equipment when scoring and snapping planks. It is important to use good quality, sharp blades in order to minimize damage to the planks. SONO Eclipse planks can also be cut with guillotine-type flooring cutters and power saws (e.g. circular saw, table saw, miter saw, jigsaw) as well as hand saws.

**NOTE: SONO Eclipse planks should always be cut away from the installation area in order to minimize debris and dust in the installation site. Always wear protective equipment such as safety glasses, a NIOSH-approved dust mask and gloves.**

**TOOLS AND MATERIALS REQUIRED**

- Measuring tape
- Pencil or marker
- Carpenter’s square
- Utility knife
- Pull bar
- 2” (51 mm) wide moisture resistant adhesive tape
- Handsaw or door jamb saw
- Saw (any of the following – not required if cutting planks using score and snap method):
  - Guillotine-type cutter
  - Table saw
  - Miter saw
  - Circular saw
  - Jigsaw

- 3/8” (10 mm) spacers
- Safety glasses & dust mask (NIOSH designated)
- Polypropylene appropriate glue if installing in areas where planks cannot be angled (eg. under door jambs)
- 100% flexible neutral curing silicone caulking if installing in moisture prone areas
- PE backer rod if installing in moisture prone areas

**SUBFLOOR PREPARATION**

SONO Eclipse floors can be installed over many types of subfloors as long as they are properly prepared and meet the required criteria outlined below.

**CAUTION: If you contemplate the removal of a resilient floor covering structure that contains (or is presumed to contain) asbestos, you must review and comply with all applicable regulations. Do not sand, dry sweep, dry scrape, drill, saw, bead blast, or mechanically chip or pulverize existing resilient flooring, backing, lining felt, asphalt “cutback” adhesive, or other adhesive. These products may contain asbestos fibers and/or crystalline silica. Avoid creating dust. Inhalation of such dust is a cancer and respiratory tract hazard. Smoking by individuals exposed to asbestos fibers greatly increases the risk of bodily harm. Unless positively certain that the product is a non-asbestos containing material, you must presume it contains asbestos. See “Recommended Work Practices for Removal of Resilient Floor Coverings” (rfci.com) for detailed information and instructions on removing all resilient covering structures.**

**GENERAL SUBFLOOR PREPARATIONS & PRECAUTIONS**

- Subfloors must be clean and free of dirt and debris prior to installation.
- Subfloors must be structurally sound.
- SONO Eclipse floors can be installed in bathrooms, kitchens, and entryways by following the (WET AREA RECOMMENDATIONS) section of this guide.
- Variations in the subfloor flatness should not exceed 1/4” per 10 ft (6mm per 3m) and 1/8” per 6 ft (3.175mm per 1.9m). Floors must be leveled to meet this specification prior to installation. Level by filling depressed areas with floor leveling compounds and grinding down any raised areas.
- Abrupt height differences of more than 1mm / 10cm must be corrected (for example, nail heads, concrete ridges and other similar small protrusions).
- Carpet is not a suitable underlay for SONO Eclipse floors. All carpet, carpet pad and carpet tack must be removed prior to installation.
- Care must be taken to ensure that the subfloor meets all local building codes and regulations. If installation is below grade or on grade, foundation walls must meet all local building codes and regulations.
- Crawl spaces must meet all local building codes and regulations. Any moisture or risk of moisture existing in your crawl space should be mitigated prior to installing SONO Eclipse.

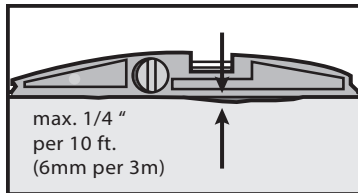

**CONCRETE SUBFLOORS**

Concrete subfloors must be properly cured and allowed to dry for at least 60 days prior to installation of SONO Eclipse. Always test concrete subfloor for moisture prior to installation. To do so:

- Tape 3’ x 3’ (91cm x 91cm) pieces of polyethylene vapor barrier to subfloor.
- If condensation appears on the film after 24 hours or concrete appears dark in color, moisture is likely present and a Calcium Chloride test must be performed.

The maximum allowable moisture emission is 8.0 lbs/1000 ft<sup>2</sup> per 24 hours (3.91 kg/100 m<sup>2</sup> per 24 hours) ASTM F1869. Alternatively, a Tramex test can be performed in accordance with ASTM F2659. However, recorded values higher than 4.5% require a Calcium Chloride test to verify that the subfloor moisture is appropriate. In Situ probe testing can also be used according to ASTM F2170 and the reading should not exceed 85%.

- A minimum 6 mil (0.2mm) polyethylene vapor barrier must be used when installing over concrete.
- Overlap vapor barrier edges by 8” (20cm) and seal with moisture resistant adhesive tape.
- Run vapor barrier 3/4” (2cm) up wall and install wall base trim over it.

**NOTE: Moisture will not affect SONO Eclipse, but moisture should be mitigated in interior environments whenever possible.**

## SUBFLOOR PREPARATION CONTINUED

### WOOD SUBFLOORS

- Wood subfloors must be structurally sound and screwed or nailed to supporting beams.
- Subfloor moisture must be tested prior to installation and should not exceed 12% throughout the installation area.
- Do not install SONO Eclipse floors over wood subfloors applied directly to concrete.

### VINYL (SHEET/TILE), LINOLEUM, CERAMIC TILE

- Existing floor covering must be in good condition with no tears, cracks or chips.
- Floor covering should be well bonded to the subfloor and the surface should be flat, smooth and level to 1/4" per 10 ft (6mm per 3m) and 1/8" per 6 ft (3.175mm per 1.9m).
- Heavily cushioned floor covering (eg. cushion vinyl) and resilient floors that exceed one layer in thickness should be removed. Follow manufacturer's guidelines when uninstalling resilient floor coverings. Wear personal protection equipment (dust mask, gloves, glasses, etc.).
- If installing over ceramic tile, any abrupt unevenness of more than 1 mm / 10 cm (eg. caused by large grout areas) should be made smooth by

applying a leveling compound.

- If vinyl, linoleum, or ceramic tile is installed over concrete, a 6 mil (0.2mm) vapor barrier must be installed over it.
- Overlap vapor barrier edges by 8" (20cm) and seal with moisture resistant adhesive tape.
- Run vapor barrier 3/4" (2cm) up wall and install wall base trim over it.

### INSTALLATIONS OVER RADIANT HEATING SYSTEMS

SONO Eclipse can be installed over in-floor heating systems, but floor temperature should never exceed 84° F (29° C).

- In-floor heat systems must be operating for a minimum of 3 weeks prior to installation of SONO Eclipse floors.
- Follow procedures as outlined in the Concrete Subfloors section of this guide.
- Do not install SONO Eclipse directly over electric wires or mats.

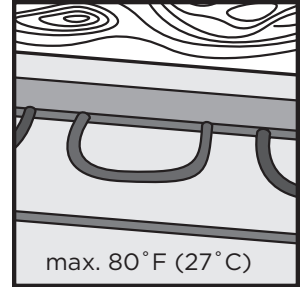

## ROOM PREPARATION

### WALL BASE /TRIM

- Removal of existing wall base/trim is optional. If you decide not to remove your wall base then you will have to install quarter-round moldings after installation of your SONO Eclipse floor is complete.
- Wall base or trim will need to be installed once the flooring installation is complete to cover the expansion space around the perimeter of the room.
- Always nail/adhere wall base and trim to the wall. Never nail/adhere it to the flooring.

### WALL IRREGULARITIES

Walls are not always perfectly straight. SONO Eclipse floors will need to be cut so as to fit within irregularities of your walls. To do so:

1. Install a complete first row of SONO Eclipse floors (following the Installation Procedures below) and ensure that all long edges of the SONO Eclipse flooring are aligned flush with one other.
2. Slide the whole row against the wall; you will now notice any wall irregularities (i.e. areas where the wall is not straight).
3. Trace the contour of the wall onto the row of SONO Eclipse flooring with a pencil or marker. Once traced, uninstall the planks carefully so as to not damage the locking system and cut along the traced line (see Plank Removal section below).
4. Re-install the planks leaving the necessary 3/8" (10mm) expansion space between them and your wall.

### CABINETS & ISLANDS

- Always install cabinets and islands prior to installing SONO Eclipse floors.
- If cabinets need to be installed after SONO Eclipse is installed they should be mounted to the wall and in a manner that does not pin SONO Eclipse and prevent it from performing as a floating floor.

### DOORS & DOOR JAMBS

SONO Eclipse floors should be installed under door jambs. As such door jambs will need to be undercut accordingly. To do so:

- Use a SONO Eclipse flooring off-cut to support your saw blade at the correct height for undercutting.
- Check door clearances and make any necessary height adjustments before installing SONO Eclipse floors.
- Make sure to leave the 3/8" (10mm) expansion spacing from the wall under the door jamb.

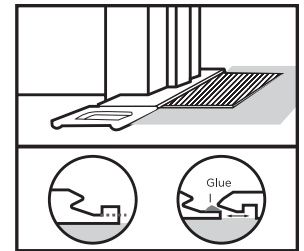

**TIP: If possible, it is often easiest to start at the door of the room so that the first plank can be easily slid under the door jamb.**

- In some cases you may have to modify a plank's locking system as a door jamb may prevent you from angling it into place. To do so, safely remove the vertical section of the groove. This will allow you to slide planks together horizontally. Apply a small amount of adhesive suitable for gluing polypropylene into the plank's groove and slide the plank into place.

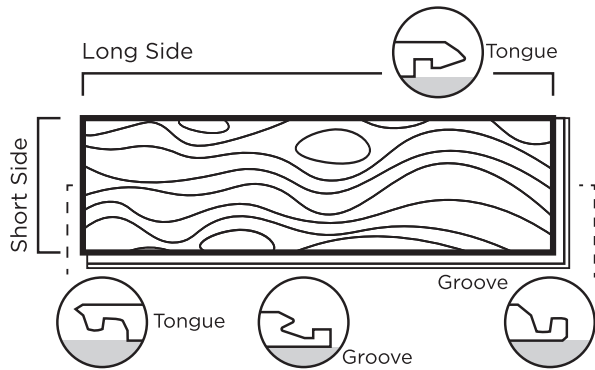

- It is recommended that planks be mixed from at least three cartons to achieve the most natural and varied appearance. There are 18 unique planks in every SONO Eclipse design. However, during production, the same plank may be inserted into one carton multiple times. It is important to mix planks from multiple cartons and review the installation often to ensure the most random appearance.
- Inspect every plank for damage and visual defects before installing it. DO NOT INSTALL damaged or defective planks.
- Never force planks together using excessive force. If planks are not fitting together easily check joint alignment and inspect for debris in the joints.
- SONO Eclipse planks should install with thumb pressure. If the use of a mallet is desired for connecting the short ends of the planks, do not tap directly onto planks you are installing. Place a small scrap piece on top of the joint you are connecting and tap it to protect the planks you are installing. Only a small amount of force is required.
- The first and last row of the installation should be wider than 3.5" (9cm). To ensure this will be the case, prior to installation:
  1. Measure the width of the room and divide it by the width of the planks you are installing.
  2. If the remainder is less than 3.5" (9cm) cut 3.5" (9cm) from the width of the first row. If this is not possible, simply ensure that both edge planks are as even in width as possible.
- The first and last plank in a row should be a minimum of 16" (40cm) long.
- Stagger the planks from row to row by a minimum of 16" (40cm).
- Prepare the subfloor and room as per the corresponding instructions found in this guide.
- Use spacers to maintain the 3/8" (10mm) expansion space between the first row and the wall.
- Select a starting corner of the room and work from left to right.

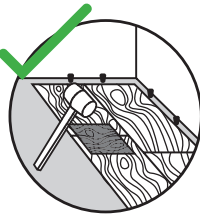
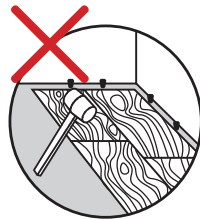

## INSTALLING THE FIRST ROW

You can connect planks in your first rows in two ways:

### Method #1:

1. Lay the first plank with the long edge tongue facing the wall.
2. Lay the second plank flat on the floor and adjacent to the first plank with the short edge joint aligned with the groove of the first plank.
3. Slide the planks perpendicular to each other engaging the short edge locking system.
4. Continue in this manner until the first row is complete, cutting the last plank to complete the row.
5. Use the remainder of the last plank of the first row to start the second row provided that it is a minimum of 16" (40cm) long.

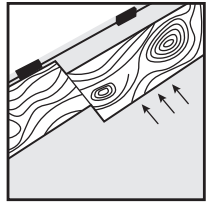

### Method #2:

1. Lay the first plank with the long edge tongue facing the wall.
2. Lay the second plank flat on the floor with the short edge joint aligned directly over the groove of the first plank.
3. Apply downward force with thumbs to connect the two planks together
4. Continue in this manner until the first row is complete. You will have to cut the last plank to complete the row.
5. Use the remainder of the last plank of the first row to start the second row provided that it is a minimum of 16" (40cm) long.

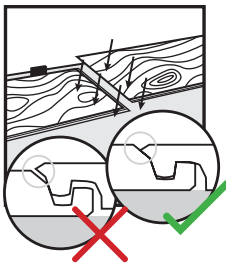

It's important that the long edges of the first row be perfectly straight and aligned in order to facilitate ease of installation of all other rows.

**TIP: You can use an extra plank as an alignment tool. Once you install planks of your first row together, temporarily install an extra plank that spans both first row planks you want to align. This extra plank will automatically align the first row plank's long edges. Do this down the length of your first row. The alignment planks are removed prior to continuing with your installation.**

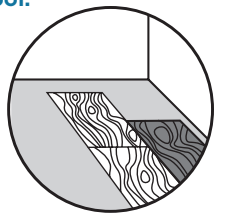

## ALL OTHER ROWS

1. To install the first plank of the second row, place its long edge tongue into the previous row's long edge groove.
2. Lift the long edge groove side only to approximately a 30° angle so the edge you're holding is lifted off the floor, but the opposing long edge is resting in the previous row's groove.

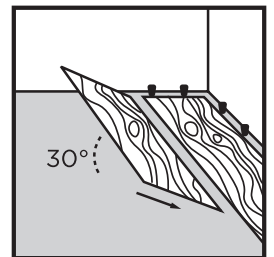



## INSTALLATION PROCEDURES

- Lower the plank to lock it into the previous row (a slight up/down, oscillating movement together with some force in the direction of the previous row may help to lower the plank).

**TIP: Inspect the width of the long side bevel for uniformity. If the bevel is not even on both sides the connection is not correct.**

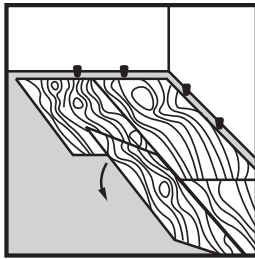

- To install the remaining planks, first install the long edge of the second plank to the previous row.
- Before lowering the plank, make sure its short end tongue overlaps with the previous plank's short end groove.
- Lower the plank slowly (a short oscillating or up-and-down motion may help to seat the plank into the proper position).
- Apply pressure to the plank's short edge starting close to the previous row and then engaging towards yourself across the width so as to activate the MegaLoc locking mechanism.
  - Thumb pressure should lock the plank in place but if more pressure is required, light tapping with a mallet is acceptable. Do not tap directly onto the

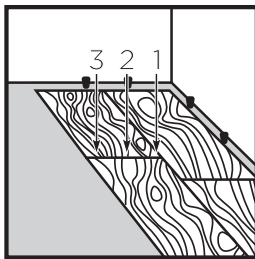

- installed planks. Place a scrap piece on top of the joint you are working on to tap on.
- Inspect every joint to ensure it is properly locked. Height differences from plank to plank at the joints is a sign of joints not being properly locked or damaged

**NOTE: Planks are designed to interlock easily and with a small amount of pressure; if this is not the case, inspect the connection system for damage or debris.**

- Continue in this manner until your installation is complete.
- Remove all spacers.
- Install quarter rounds, base boards and all other moldings.
- Clean the floor and inspect it to ensure all joints are locked in place.

## PLANK REMOVAL

- To remove planks, lift the long edge of the last installed row all at once to approximately 30 degrees in order to disconnect the long edge installation mechanism.
- Once this row has been removed, disconnect each individual plank from one another by starting at the right-most plank and sliding it horizontally to disengage it from the previous plank.
- If you plan to re-install them, care should be taken so as not to damage the installation mechanism.

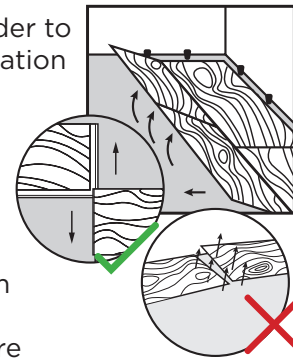

## RECOMMENDATIONS FOR WET AREA INSTALLATION

When installing in moisture prone areas (eg. kitchens, bathrooms, entryways), seal all expansion spaces with compressible PE foam backer rod and 100% neutral cure flexible silicone caulk as described in the following procedure.

**NOTE: SONO Eclipse is not a water barrier. When excessive moisture accumulates in buildings or on building materials, mold and/or mildew growth can occur. Care should be taken to address any moisture related issues prior to installing SONO Eclipse.**

**NOTE: Do not use acrylic based caulks as they are rigid and will prevent the floor from expanding and contracting. Use only neutral curing 100% flexible silicone caulk. Do not use acetoxy silicone caulks as they may damage SONO Eclipse.**

## PROCEDURE:

- Insert 1/2" (12mm) compressible PE foam backer rod into room perimeter expansion space and cover completely with flexible silicone caulk.
- Insert 3/8" (10mm) compressible PE foam backer rod at transitions and cover completely with flexible silicone caulk.
- Use 100% flexible neutral cure silicone caulking around door frames and other fixed objects (eg. plumbing).
- Install baseboards, quarter-rounds or other applicable moldings and immediately wipe up excess caulk.
- Ensure baseboards or quarter-rounds are attached to walls, not floors.

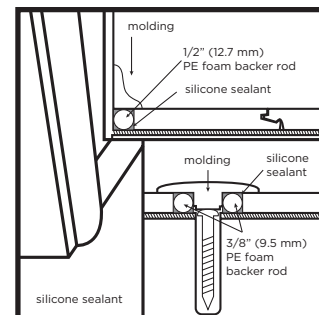

### ADDITIONAL SUBFLOOR CONDITIONS

- The subfloor in addition to being level, dry, and free of cracks must be pH Neutral (less than or equal to 9).

### ADHESIVE

- There are a variety of adhesives that are approved for use with SONO, for a full list of approved adhesives please contact our support line at 888.255.3412.
- All specifications of the adhesive manufacturer such as setting, trowel recommendations, and/or laying time must be followed. The adhesive must be applied over the entire installation area.

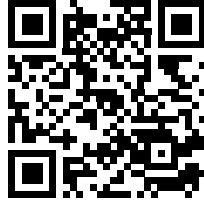

### LAYING PLANKS

- We recommend cutting and dry fitting the first three rows before applying adhesive to the subfloor. Once the dry fit is prepared then apply adhesive to the required area and place the previously fitted planks on the glue bed. Next apply adhesive to the adjoining area (we recommend only 3-4 rows or an amount that you can process comfortably). Continue with laying the planks row by row taking care to ensure that each plank is engaged to the previous planks and that each plank is securely and evenly pressed into the adhesive bed.
- Roll SONO immediately after installation with a 100 lb. (45.4 kg) roller. Work from the center towards the edges to expel trapped air.